

# User manual

## record system 20

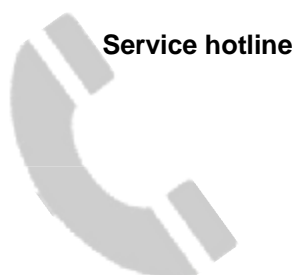

**Manufacturer**  
agtatec ag  
Allmendstrasse 24  
CH-8320 Fehraltorf



**Service hotline**

**Distributor**

Article no. 020.110.469A

---

## Table of contents

|           |  |           |
|-----------|--|-----------|
| <b>1.</b> | <b>General remarks .....</b>   | <b>3</b>  |
| 1.1.      | Target groups .....  | 3         |
| 1.2.      | Door care.....   | 3         |
| 1.3.      | Maintenance .....  | 3         |
| <b>2.</b> | <b>Safety instructions .....</b>                                       | <b>4</b>  |
| 2.1.      | Use for the intended purpose.....                                      | 4         |
| 2.2.      | General safety and accident prevention regulations.....                | 4         |
| 2.3.      | Control of safety devices .....  | 4         |
| <b>3.</b> | <b>Operating instructions .....</b>                                    | <b>5</b>  |
| 3.1.      | Selection of operating modes .....                                     | 5         |
| 3.2.      | Selection of special functions.....                                    | 6         |
| 3.3.      | Locking the control unit over keyboard.....                            | 7         |
| 3.4.      | Locking the control unit with key a switch (option) .....              | 7         |
| <b>4.</b> | <b>Manual opening and closing in case of failure .....</b>             | <b>8</b>  |
| 4.1.      | Manual opening (without manual unlocking device) .....                 | 8         |
| 4.2.      | Manual closing.....  | 9         |
| <b>5.</b> | <b>Operating the door in emergency .....</b>                           | <b>11</b> |
| 5.1.      | Emergency opening with current supply .....                            | 11        |
| 5.2.      | Emergency opening in case of power failure with auxiliary battery..... | 11        |
| 5.3.      | Emergency operating using bowden cable (option) .....                  | 11        |
| <b>6.</b> | <b>Behaviour in event of faults .....</b>                              | <b>13</b> |
| 6.1.      | Display on the control unit.....                                       | 13        |
| 6.2.      | Possible troubleshooting.....  | 13        |
| 6.3.      | Resetting the control module .....                                     | 13        |
| 6.4.      | Control unit BDE-D does not react.....                                 | 14        |
| <b>7.</b> | <b>Functions and safety check .....</b>                                | <b>15</b> |
| 7.1.      | General remarks.....   | 15        |
| 7.2.      | Technical data and operating conditions.....                           | 15        |
| 7.3.      | Monthly check-up list .....  | 16        |

## 1. General remarks

### 1.1. Target groups

This user's guide is meant for the following users:

- Operators of the automatic sliding door record system 20:  
the persons in charge of the technical maintenance of this door installation
- End-users of the door installation:  
the persons who use the door functions daily and have been appropriately trained

This manual explains how to operate the sliding door record system 20. It is the basis for optimal functioning and gives instructions for troubleshooting. Excerpts of this document can also be given to the persons responsible for the daily operating of the door.

The operator should read this user's guide before commissioning the door and observe the safety instructions!



Please keep this document in a safe, convenient place beside the sliding door.

### 1.2. Door care

The entire door installation – including sensors and safety devices – can be cleaned with a damp cloth and commercially available cleaning agents (do not use abrasive cleaning agents or any solvent). First test the product selected on a non-visible spot. The floor tracks should be kept free from dirt.



#### NOTE

To perform this work it is recommended that the operating mode  (locked) or  (continuously open) be selected, in order to avoid possible injury due to uncontrolled door movements.

### 1.3. Maintenance

It is recommended that a technical safety test and a service be carried out by one of our record service technicians or by an authorised partner, before first commissioning and as required – but at least once a year.

A display on the BDE-D control unit will show when maintenance is due. These display messages occur at various intervals which are defined by the number of opening cycles or after a certain operating time.

Regular testing and servicing by our fully trained staff – or by staff approved by record – offers the best guarantee for durability and trouble-free, reliable operation.

**We recommend that a service agreement be arranged with the record service centre in charge of your region.**

## 2. Safety instructions

The record system 20 sliding door has been developed with state of the art technology and recognised technical safety regulations.

### 2.1. Use for the intended purpose

The record system 20 is designed exclusively for normal service in dry rooms.

The intended purpose includes observing the operating conditions as specified by the manufacturer, in addition to regular care, maintenance and repair.

Unauthorised modifications to the automatic door will release the manufacturer from all liability for any resulting damage.

### 2.2. General safety and accident prevention regulations

No safety devices (sensors, protective screens, etc.) may be dismantled or put out of service.

No objects may be present in the opening/closing area of the sliding door, in order to avoid squashing and cutting!

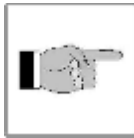

#### NOTE

The installation is **not** intended to be disconnected from the mains at night!

### 2.3. Control of safety devices

Beside the maintenance carried out at regular intervals by a record service technician or authorised person, it is recommended, for additional safety, that the operator regularly controls the essential elements of the door.

You will find a check-list of the functions to be tested monthly at the end of this document.









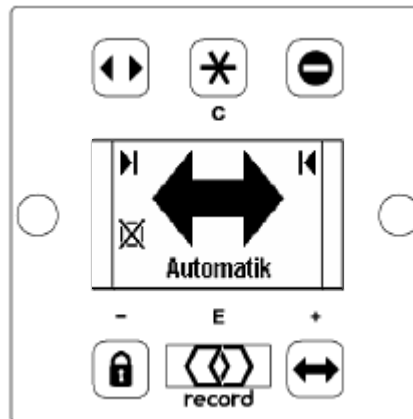

## 3. Operating instructions

The electronic control unit with display (BDE-D) has been designed to operate the automatic sliding door installation.

### 3.1. Selection of operating modes



The electronic control unit BDE-D is a user-friendly input and output unit to control and customise (optional) record door operation. The LCD display with backlight gives information about the door status with symbols and clear text. Error messages are displayed as text.



| Key   | Operating mode        | Symbol   | Function  |
|---|-----------------------|--|---|
|  | Automatic             | <br><b>Automatic</b>  | <ul style="list-style-type: none"> <li>Door opens unhindered from inside or outside</li> <li>Maximum opening width (summer opening)</li> </ul>                                    |
|  | Continuously open     | <br><b>Cont. open</b> | <ul style="list-style-type: none"> <li>Door remains open until another operating mode is selected</li> </ul>  |
|  | One way               | <br><b>One-way</b>    | <ul style="list-style-type: none"> <li>Door opens only in one direction (e.g. for shop closing time)</li> </ul>   |
|  | Locked                | <br><b>Locked</b>     | <ul style="list-style-type: none"> <li>Door is closed and locked (if locking system has been installed)</li> <li>Door remains locked even in the case of power failure</li> </ul> |
|  | Reduced opening width | <br><b>Automatic</b>  | <ul style="list-style-type: none"> <li>Door opens unhindered from inside or outside</li> <li>Reduced opening width (winter opening)</li> </ul>                                    |



#### NOTE





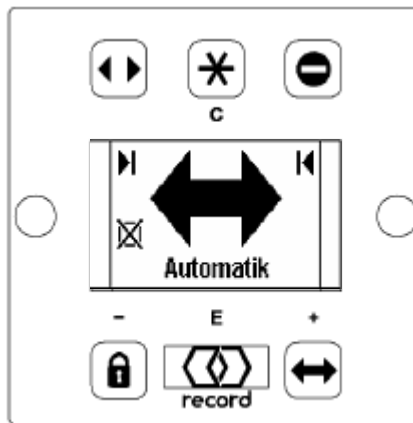



Reduced opening width is also effective with the operating modes  (one way) and  (continuously open).

## 3.2. Selection of special functions



| Key | Function       | Display           | Description   |
|-----|----------------|-------------------|---|
|     | Manual mode    | <br><b>Manual</b> | <ul style="list-style-type: none"> <li>Press key twice running</li> <li>Door opens / stops on 2nd key stroke</li> <li>Door can be manoeuvred by hand</li> </ul> <b>Back to operating mode</b> <ul style="list-style-type: none"> <li>Activation of the selected key (e.g. automatic)</li> </ul> |
|     | Manual mode    | <br><b>Manual</b> | <ul style="list-style-type: none"> <li>Press key <i>for 2 seconds</i></li> <li>Door can be manoeuvred by hand</li> </ul> <b>Back to operating mode</b> <ul style="list-style-type: none"> <li>Activation of the selected key (e.g. automatic)</li> </ul>  |
|     | Single opening | <br><b>Locked</b> | <ul style="list-style-type: none"> <li>Door is closed and locked</li> <li>1 keystroke unlocks the door</li> <li>An opening/closing cycle is performed</li> <li>Once closed, door locks again</li> </ul>   |

## 3.3. Locking the control unit over keyboard

| Key series  |   |   | Display   | Description  |
|---|---|---|---|--|
| Locking the control unit  |   |   |   |  |
|  |  |  |  | <ul style="list-style-type: none"> <li>Undesired manipulation of the control unit is hindered</li> <li>Panel is locked</li> <li>Locked status of the BDE-D is displayed</li> </ul> |
| Unlocking the control unit  |   |   |   |  |
|  |  |  |  | <ul style="list-style-type: none"> <li>Free selection of operating modes and special functions is ensured</li> </ul>   |



### NOTE

The installation remains in the mode of operation previously selected.

## 3.4. Locking the control unit with key a switch (option)

The control unit BDE-D can be efficiently protected against unauthorised changes of operating mode by an additional key switch. Such a key switch is usually placed near the BDE-D.

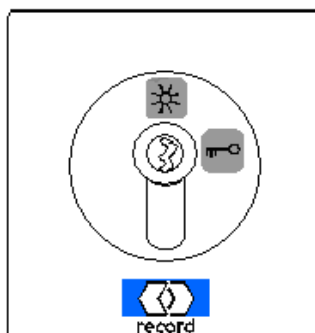
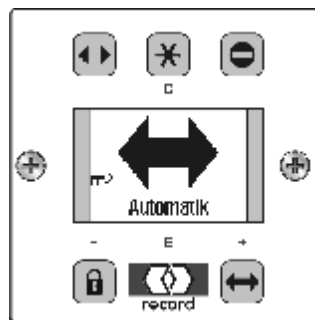

# Manual opening and closing in case of failure 4

## 4. Manual opening and closing in case of failure

### 4.1. Manual opening (without manual unlocking device)

**Initial situation:** Door is disconnected from the mains, blocked in closed position and locked.



- Opening the operator casing

*Note:*

If you pull near the hinges, it will assist the opening of the casing

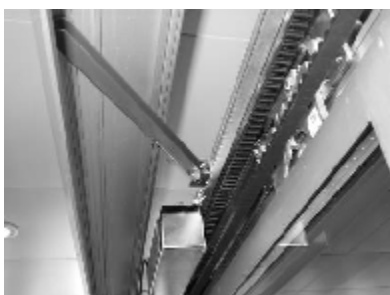

- Swivel out the red holding bar in order to keep the casing in open position

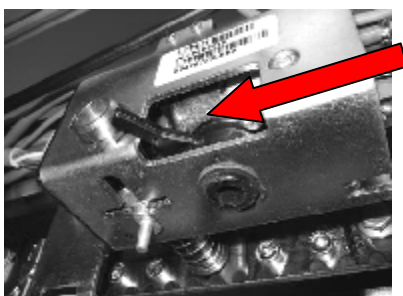

- The locking system is provided with an unlocking lever

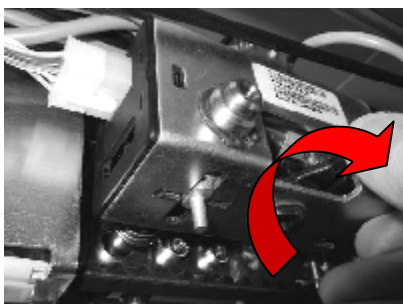

- Turn the lever clockwise
- Door unlocks and can be pushed open by hand
- Close the casing with a strong pressure on the area of the hinges



# Manual opening and closing in case of failure 4

## 4.2. Manual closing

**Initial situation:** Electric power is supplied. Door remains blocked in open position.

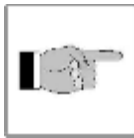

### NOTE

According to the kind of failure, the procedure for a manual closing will be different. Please follow the steps described below.

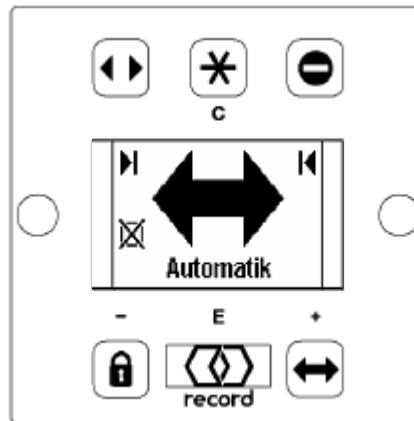

### 4.2.1. Manual closing – step 1

| Key | Function    | Display    | Description  |
|-----|-------------|------------|--|
|     | Manual mode | <br>Manual | <ul style="list-style-type: none"> <li>Press key twice running</li> <li>Door can be opened or closed by hand</li> </ul> <p><b>Temporary door operating (e.g. in case of low outside temperatures)</b></p>  |
|     | Locked      | <br>Locked | <p><b>Night locking</b></p> <ul style="list-style-type: none"> <li>Press <i>additionally</i> the "locked" key</li> <li>Slide the door by hand to the closed position</li> <li>Door is closed – and locked (if applicable)</li> </ul> <p><b>Inform record service point (telephone number displayed on BDE-D)</b></p> |

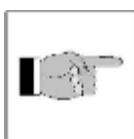

### NOTE

If the door still can not be moved by hand and locked, please follow the steps described below.

# Manual opening and closing in case of failure 4

## 4.2.2. Manual closing – step 2

If the attempts to close and lock the door described under "step 1" have remained unsuccessful, it indicates a severe failure. Please proceed as follows:

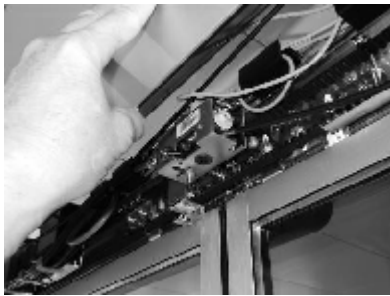

- Set the door on "manual mode" with the control unit (see § 4.2.1.)
- Open the operator casing (swinging it out)

*Note:*

If you pull near the hinges, it will facilitate the opening of the casing

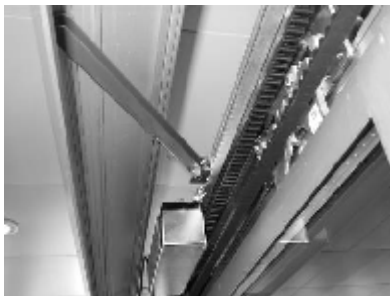

- Swivel out the red holding bar in order to keep the casing in open position

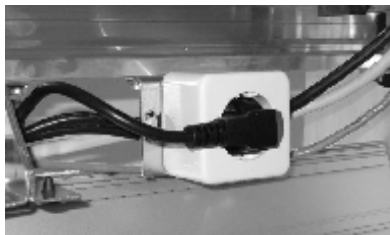

- Disconnect the installation from the power supply
- The socket is located under the operator casing

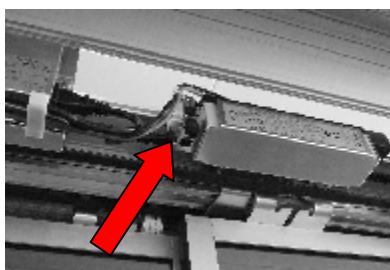

**Installations with in-built emergency battery:**

- Unscrew the battery fuse
- The battery is located under the operator casing

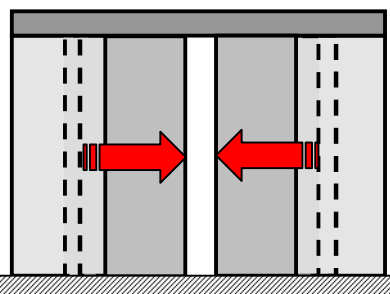

- Slide the door by hand to the closed position

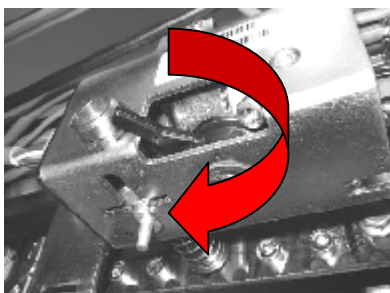

- Turn the unlocking lever clockwise and hold it in this position so that the door can close completely
- Door will lock as soon as you release the unlocking lever
- Manually check that the door is properly locked
- Leaving the building is only possible through a second exit

**Inform record service point  
(telephone number displayed on BDE-D)**

## 5. Operating the door in emergency

In accordance with country-specific safety regulations (concept of emergency exit, etc.) the doors are fitted with an emergency opening device.

### 5.1. Emergency opening with current supply

By activating the emergency opening switch (optional), which must be placed beside the installation, the door will open as long as the operating mode "locked" has not been selected. In this operating mode the door will remain locked.

To re-start the installation again, the emergency opening switch must be reset by hand, either through a rotation or a pulling (different procedures depending on the version of the switch).

### 5.2. Emergency opening in case of power failure with auxiliary battery

- Emergency opening in case of power failure takes place via an auxiliary battery, which triggers a single opening of the door (except if function "locked" has been selected).
- With a higher-performance battery, all functions of the automatic door are maintained over several opening cycles. The number of openings depends essentially on the weight of the door leaves and the state of the battery.
- In case of low battery, the last movement is selectable – either opening or closing.
- Unlocking the door is still possible with the key-operated contact/switch (optional).

### 5.3. Emergency operating using bowden cable (option)

This device, available in several versions, is mounted inside and/or outside and allows the unlocking of the door, according to the procedure below.

#### 5.3.1. Available versions

The available versions are illustrated below. They are basically identical in their functioning.



#### 5.3.2. Procedure for an emergency opening



##### ***Emergency opening***

- Open the unlocking flap
- Pulling the unlocking flap downward unlocks the door
- Display on the BDE-D:  
à Error no. 31 / Emergency stop
- Door can be slid open by hand

# Operating the door in emergency 5

## 5.3.3. Closing and locking the door



- Operate the emergency opening
- This causes the locking device to be "unlocked"

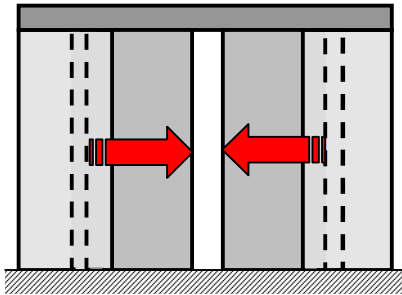

- Slide the door by hand to the closed position
- Keep the door leaves in the closed position



- Close the unlocking flap
- The door is now locked

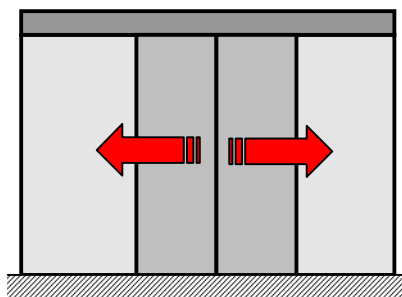

- **Check by hand that the door really is locked**

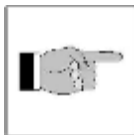

### NOTE

Same procedure for the other actuators.

## 6. Behaviour in event of faults

In case the installation fails, a message is displayed on the control unit BDE-D.

### 6.1. Display on the control unit

- Status messages are displayed with status number and text.
- The display changes alternately from white to black.
- After 10 seconds, the telephone number of the relevant service centre is alternately displayed.

### 6.2. Possible troubleshooting

- Based on the status display some errors can sometimes be eliminated.
- If you are not sure, please contact the relevant service centre.
- Before you call, write down the data displayed on the BDE-D. This information provides the technician with important indicators for troubleshooting.
- If several status messages are active at the same time, they are numbered: e.g. error 1/2

| Information            | Procedure  | Display examples |
|------------------------|--|------------------|
| Status text and number | <ul style="list-style-type: none"> <li>• Is automatically displayed on the BDE-D</li> </ul>  |                  |
| Software versions      | <ul style="list-style-type: none"> <li>• Press the following BDE-D key for 2 seconds</li> </ul> <div style="text-align: center;"> <p><b>E</b></p> </div> |                  |

### 6.3. Resetting the control module

In certain cases, failures can be repaired by resetting the control (STM). Proceed as follows:

- Make sure that the operator casing is closed, and that nobody is obstructing the door or is approaching it, thereby triggering an opening.



|                         |     |  |
|-------------------------|-----|--|
| <p><b>E</b></p>         |     | <b>Press record key &gt; 5 seconds</b>   |
| <p></p> <p><b>C</b></p> | No  | <div style="border: 1px solid black; padding: 5px; width: fit-content; margin: auto;"> <p style="text-align: center;">No</p> <hr/> <p style="text-align: center;">Reset control?</p> <hr/> <p style="text-align: center;">Yes</p> </div> |
| <p><b>E</b></p>         | Yes |  |

- The door is reset.
- After a reset takes place, the first door movement occurs at reduced speed.
- If an error is still displayed on the BDE-D after a reset of the control module, please contact our service centre, **stating the error message**.

## 6.4. Control unit BDE-D does not react

If the control unit BDE-D does not react when the keys are pressed or if no message appears on the display, a reset of the control unit can eliminate the problem.

Proceed as follows:

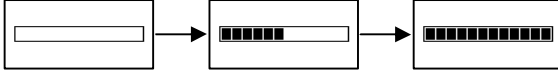
| RESET HARDWARE BDE-D  |   |
|---|---|
| <b>E</b><br><br>record | <b>Press record key &gt; 12 seconds</b>   |
|                        | Display without any message   |
|   | Connection to control...<br><br>Connection has been established (example)<br><div style="border: 1px solid black; padding: 5px; width: fit-content; margin: 0 auto;">                         STA20 V1.0<br/>                         Basic operator                     </div> |

- After resetting, the control unit is again operational.
- If this is not the case, please inform our service centre.

## 7. Functions and safety check

### 7.1. General remarks

According to the legal provision in force, the operating entity of the automatic door is responsible for its maintenance and for the users' safety, as soon as the installation has been handed over.

The monthly inspection of single elements by the operator requires little time investment and reinforces the prevention of accidents caused by an inappropriate use of the door.

### 7.2. Technical data and operating conditions

#### 7.2.1. Power supply data

Mains voltage (230V): 100-240 VAC, 50 / 60 Hz

Rated power: 140 VA

#### 7.2.2. Ambient conditions

Temperature range: -15° to +50° C

Humidity range: up to 85% relative humidity, non-thawing

## 7.3. Monthly check-up list

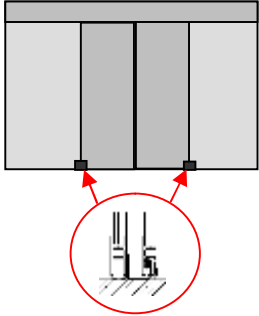
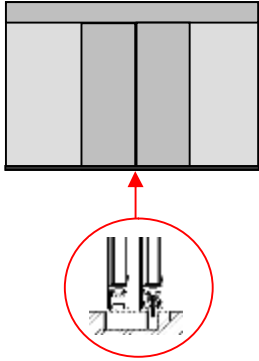
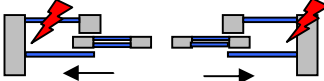
| Test / control  | Procedure   | Result expected  |
|---|---|--|
| Motion detector   | <ul style="list-style-type: none"> <li>Walk at normal speed towards the door (from inside or outside)</li> </ul>  | <ul style="list-style-type: none"> <li>The sensor must cover the whole width of passage</li> <li>The door opens in time and at an appropriate speed to allow unhampered passage through the doorway</li> </ul>                           |
| Door leaf / side screen   | <ul style="list-style-type: none"> <li>Verify the state of the glazing</li> <li>Verify the state of the seals and profiles</li> </ul>   | <ul style="list-style-type: none"> <li>No glass damage</li> <li>No seals torn off (preventing energy loss)</li> <li>The door is the "visiting card" for your company. Take care it is maintained in a perfect condition</li> </ul>       |
| Door leaf guides<br>  | <ul style="list-style-type: none"> <li>Control the door leaf guides</li> <li>These could be damaged by impacts (e.g. from trolleys)</li> <li>Door leaf guides can show exceptional signs of wear and tear due to intensive use as well as dirt</li> </ul> | <ul style="list-style-type: none"> <li>Door leaf must slide smoothly</li> <li>Bottom or vertical profiles show no scratch marks</li> <li>Door leaf guides must not produce any unusual noise during the opening/closing phase</li> </ul> |
| Full width floor track<br>(instead of single door leaf guides)<br> | <ul style="list-style-type: none"> <li>Set the door on manual mode (see chapter 3.2.)</li> <li>Clear the track of dirt, cigarette butts, etc.</li> </ul>  | <ul style="list-style-type: none"> <li>Door leaf must slide smoothly</li> <li>The movement of the door must not be hindered by dirt</li> </ul>   |
| Operator casing   | <ul style="list-style-type: none"> <li>Check the attachment of the operator casing</li> </ul>   | <ul style="list-style-type: none"> <li>It must be completely closed and must correctly engage in the hinges</li> </ul>   |
| Protective screen<br>(optional – country-specific)<br>             | <ul style="list-style-type: none"> <li>Check the mechanical state of the protective screen</li> <li>Particularly check the closing mechanism</li> </ul>   | <ul style="list-style-type: none"> <li>A protective screen reduces risk of squashing and cutting</li> </ul>  |